

DATE REQUIRED:

DEPENDING ON COMPLEXITY, DELIVERY TIMES MAY VARY.  
IF REQUIRED URGENTLY PLEASE CALL 0870 444 8644

## ORDERING GUIDE: BDA/BDG ENGINE SYSTEMS (CONVENTIONAL)

### IGNITION LEAD ORDER DETAIL

Please complete in **BLOCK CAPITALS**

Dealer: \_\_\_\_\_

Your Name: \_\_\_\_\_

Address: \_\_\_\_\_

Post Code: \_\_\_\_\_

Telephone: \_\_\_\_\_ Mobile: \_\_\_\_\_

Fax: \_\_\_\_\_

#### LEAD TYPE REQUIRED (please tick ✓)

Copper Core (Black / Unprinted)  7mm

Electroports 70 (Black)  7mm

Electroports 80 (Blue)  8mm

Competition KV85 (Red)  8.5mm

If unsure, please refer to:  
[www.magnecor.co.uk](http://www.magnecor.co.uk)  
and click 'Product Information'

Or call our Technical department.

#### YOUR VEHICLE DETAILS

Vehicle Make/Model: \_\_\_\_\_ Year: \_\_\_\_\_

Engine Type: E.g. Honda Civic 1.6 \_\_\_\_\_

Engine Code: E.g. B16A2 \_\_\_\_\_

#### DISTRIBUTOR CAP TYPE

Make: \_\_\_\_\_ Model: \_\_\_\_\_

BOOT TYPE AT DISTRIBUTOR CAP:  Straight  90° (right angle)

#### FITTING TYPE (please see reference images below and tick or circle your type)

Conventional/DIN

Pin/M4

SAE/Post/Male

Other-Please Sketch

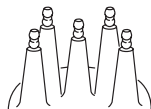
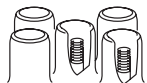

### MEASURING YOUR LEADS CORRECTLY

PLEASE READ CAREFULLY TO ENSURE MEASUREMENTS ARE CORRECT.

When measuring existing ignition leads, measure from the spark plug metal terminal end to the distributor or coil metal terminal end (see diagram 1). For leads with deep boots (e.g. 16 valve engines) measure from the centre (see diagram 2). It is best to remove ignition leads from the spark plugs before measuring if the leads are difficult to reach.

Use a dressmaker's tape or alternatively lay a flexible tube/covered wire against the existing ignition lead. These can then be easily measured after the length has been established. This is the most accurate way to arrive at the correct lead lengths.

If no ignition leads are fitted to the engine, establish length by using tubing pipe or covered wire/flex or old ignition leads to make a temporary connection from the distributor to the spark plugs. Using this method will also help ascertain the best possible lead position along the entire length of the proposed ignition lead routing.

When measuring the R-100 10mm leads in particular, remember to take into account that the physical bulk of the 10mm ignition lead might necessitate longer lead lengths in order to go around corners and accessories. Also, fitting R-100 10mm ignition leads into original equipment tubes and brackets may not be possible. However, due to its exceptional flexibility the lead will squeeze into many aftermarket 8mm or larger lead separators.

CAPACITY: \_\_\_\_\_ NUMBER OF CYLINDERS: \_\_\_\_\_

SOHC/DOHC: \_\_\_\_\_ NUMBER OF VALVES: \_\_\_\_\_

TURBO  S/CHARGED:  CARB  INJECTION:

#### COIL

Make: \_\_\_\_\_ Model: \_\_\_\_\_

Coil Lead Length: \_\_\_\_\_ (cm / inches)

#### COIL LEAD BOOT TYPES

Coil End:  Straight  90° (right angle)

Distributor End:  Straight  90° (right angle)

#### FITTING TYPE (please see reference images below and tick or circle your type)

Conventional/DIN

Pin/M4

SAE/Post/Male

Other-Please Sketch

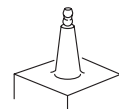
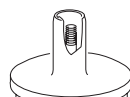
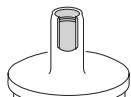

fax: **+44 (0) 870 444 6957**

International fax: **+44 (0) 1530 274624**

WHEN MEASURING YOUR CABLE LENGTHS, PLEASE MAKE ALLOWANCES FOR THE CURVATURE OF THE CABLE AS IT LEAVES THE TOP OF THE PLUG BOOT TO THE SPARK SOURCE.

Diagram 1.

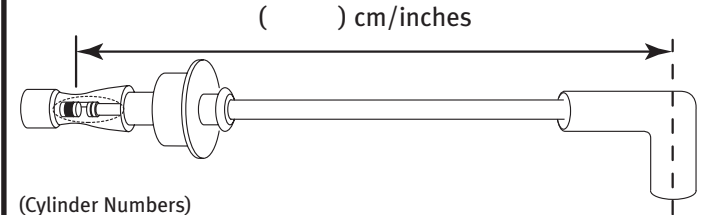

(Cylinder Numbers)

1) \_\_\_\_\_ 2) \_\_\_\_\_ 3) \_\_\_\_\_ 4) \_\_\_\_\_

OTHER RELEVANT INFORMATION: E.g. Specific Conversion Type

Diagram 2.

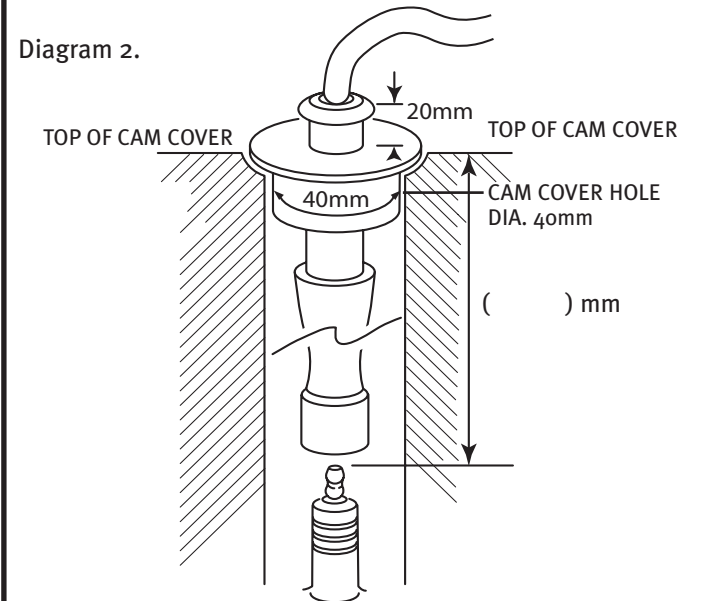

PLUG SIZE: (Please Tick)

20.8mm hex  16.0mm hex